

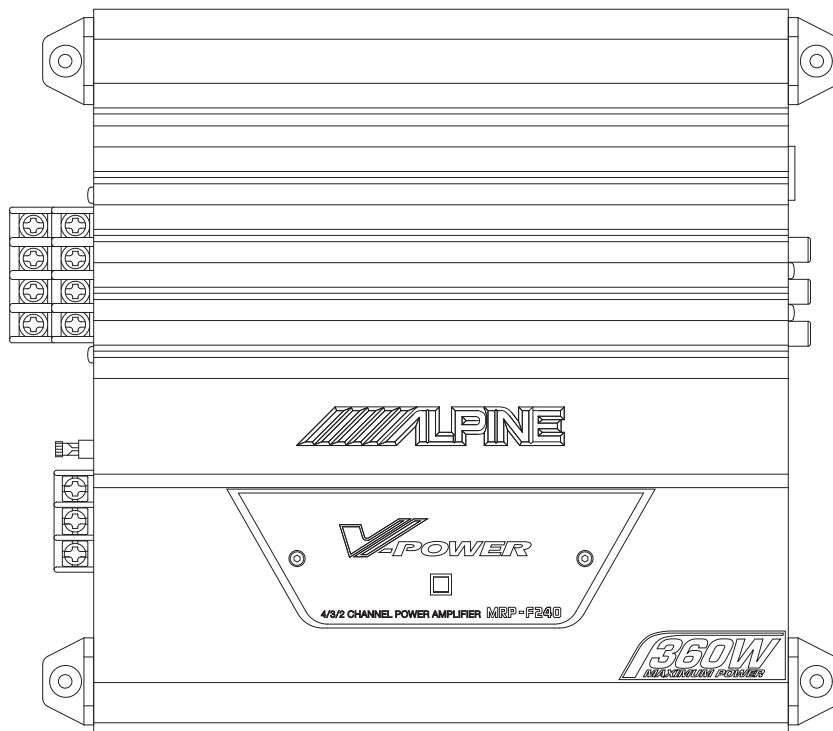

SERVICE MANUAL

4/3/2 CHANNEL POWER AMPLIFIER



[TO ALPINE Home Page](#)

1/03-A
68E35050S01



MRP-F240

<Cautions for Safe Repair Work>



The following cautions will prevent accidents in the workplace and will ensure safe products.

*The symbols indicate caution is needed to prevent injuries and damage to property.



The symbols and their meanings follow.

 Warning	If you ignore this symbol and handle the product incorrectly or unsafely, serious injury or death may result.
 Caution	If you ignore this symbol and handle the product incorrectly or unsafely, injury or only material damage may result.



*The following symbols indicate two levels of cautions.



 When you see this symbol, you have to be very careful.
 When you see this symbol, you have to follow the instructions there.



Warning

 Do not look squarely into the laser light coming from the pickup. You may lose your sight.	 Fuse Caution Always use a designated fuse. Use of an incorrect fuse may result in a fire.
--	--

Caution

 Do not allow wiring to be caught in the screw/chassis. If wiring is caught in the screw/chassis, it may cause a short circuit, resulting in a fire.	 Battery Caution Use the designated battery. Confirm the correct polarity and seat of the battery. An incorrect battery or an improperly connected or seated battery may result in a fire.
---	---

 High Temperature Caution Touching the heat sink may cause severe burns.	 Designated Parts Caution Look up the part list and ensure that only designated parts are used to prevent problems or accidents.
---	---

 Reverse Power Supply Connections or Misconnections Caution Reverse power supply connections or misconnections may cause ignition problems and smoke may result.	 Wiring Caution Ensure that the wiring is correct when rewiring to prevent problems with ignition/breakdown.
---	---

 Soldering Caution Hot solder from solder splash may cause severe burns.	 Wear Gloves Wear gloves to prevent electrical shocks or injury from the end face of the metal.
---	--

Contents

Packing Assembly Parts List

Packing Method View

Specifications

Block Diagram

Parts Layout on P.W.Boards and Wiring Diagram

Schematic Diagram

Terminal Voltage of IC/TR

Exploded View (Cabinet)

NOTE : Due to continuing product improvement, specifications and designs are subject to change without notice.

Packing Assembly Parts List

Symbol No.	Part No.	Description	Symbol No.	Part No.	Description
101	68P02294K68	OWNER'S MANUAL			
102	03E34961S01	SCR M4X20 TPG1,BLK			
103	03E34955S01	SCR M3X10(B)MCH(BLK)			
104	15E34956S01	COVER,RCA			
105	75E22439S01	HOUSING RUBBER-B			
106	75E22440S01	HOUSING,RUBBER(C)			
107	01E23875S01	ASS'Y INPUT WIRE			

Packing Method View

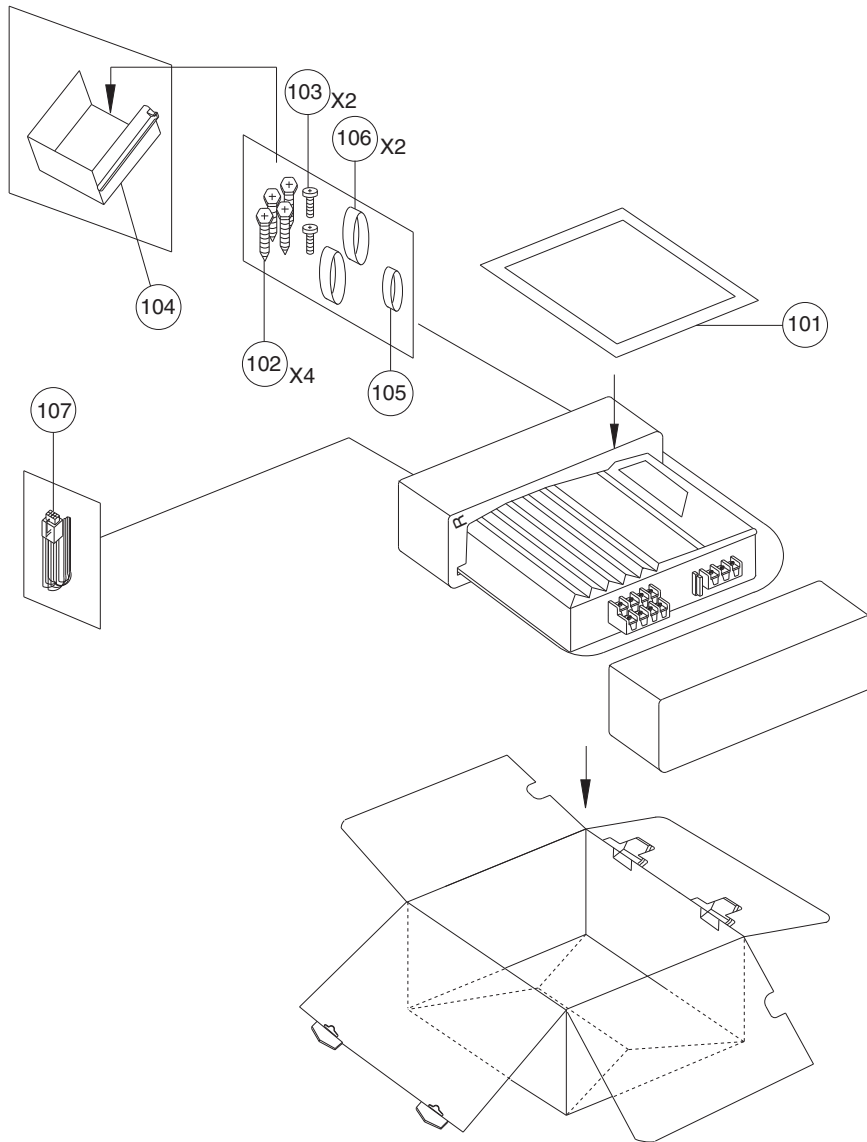

Specifications

T.H.D. (DC14.4V, 20Hz~20kHz)	4ohm-Load/4ch, 35W Output : 0.2%
	4ohm-Load/2ch (BTL), 95W Output : 1.0%
Power Output (Normal Input, DC14.4V, 20Hz~20kHz)	0.2% T.H.D., 4ohm-Load/4ch : 35W
	1.0% T.H.D., 4ohm-Load/2ch (BTL) : 90W
S/N Ratio (Ref. Output 35W/4ohm, Input Shorted)	94dB
Input Sensitivity (35W Output)	GAIN-VR Center : RCA Input : 1.1V±5dB
	SP Input : 2.2V±5dB
	GAIN-VR CW : RCA Input : 0.2V±5dB
	SP Input : 0.4V±5dB
	GAIN-VR CCW : RCA Input : 4.5V±5dB
	SP Input : 8.9V±5dB
Frequency Response Ratio (Ref. 1kHz, 0±1dB)	20Hz~40kHz
Current Drain	No Signal : 1.5A
	4ohm-Load/4ch, T.H.D. 10% : 30A
Residual Noise (Input Shorted, 4ohm-Load/4ch, VR Center)	3.0mV
Channel Separation (Input Shorted, 1kHz, 35W Output)	55dB
Remote on Voltage (1W Output)	6.5+1.0, -1.5V
Remote Current Drain	3.0mA
Back-up Current Drain	1.2mA
Input Impedance	RCA Input : 13.8±2.0kohm
	SP Input : 13.8±2.0kohm
Power Source	DC14.4V (9.0~16.0V)
Dimensions (W x H x D)	265.6 x 60 x 241.4mm
Weight	2.54kg

NOTE : Due to Continuing product improvement, specifications and designs are subject to change without notice.

Block Diagram

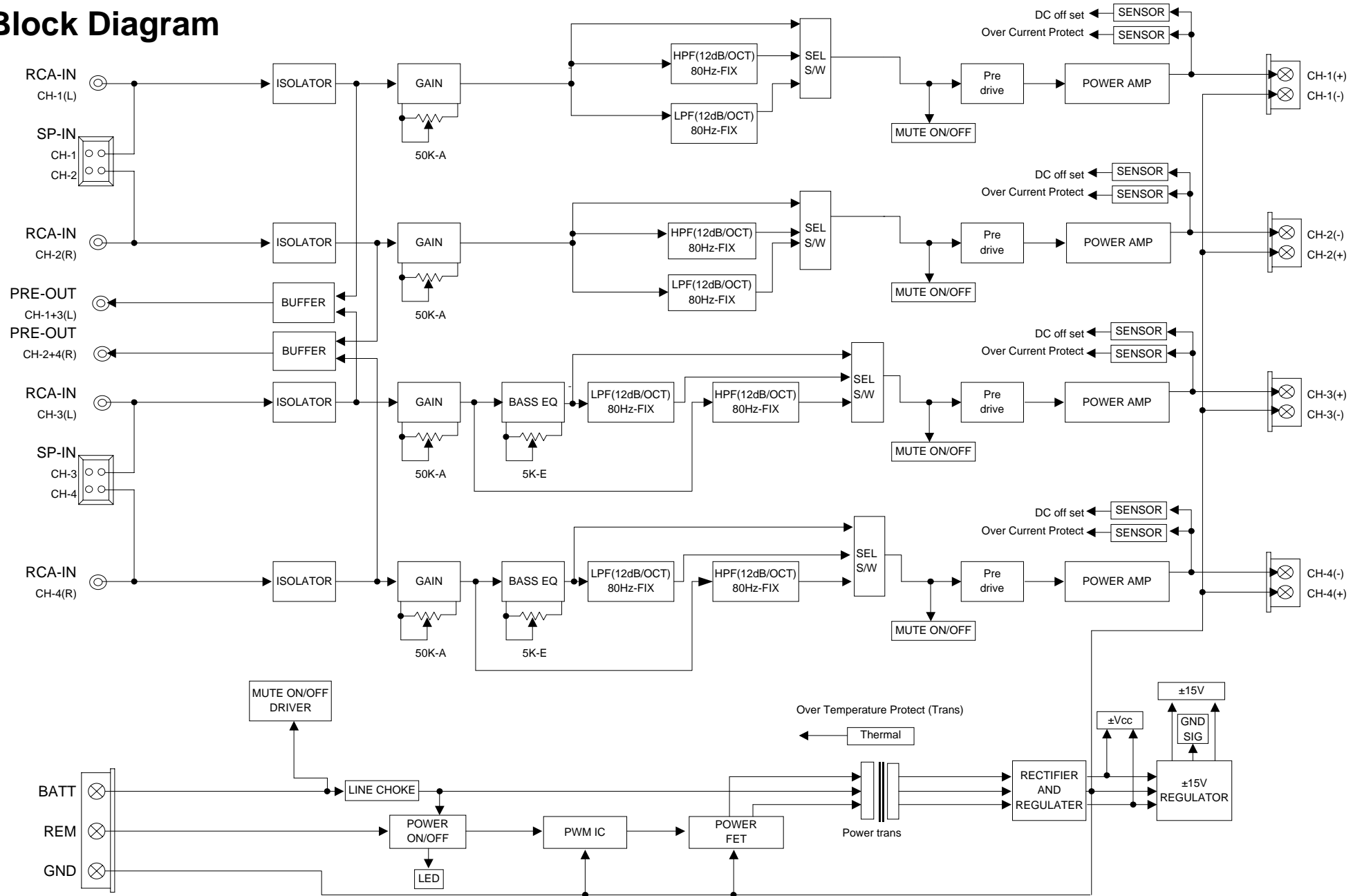

TO CONTENTS

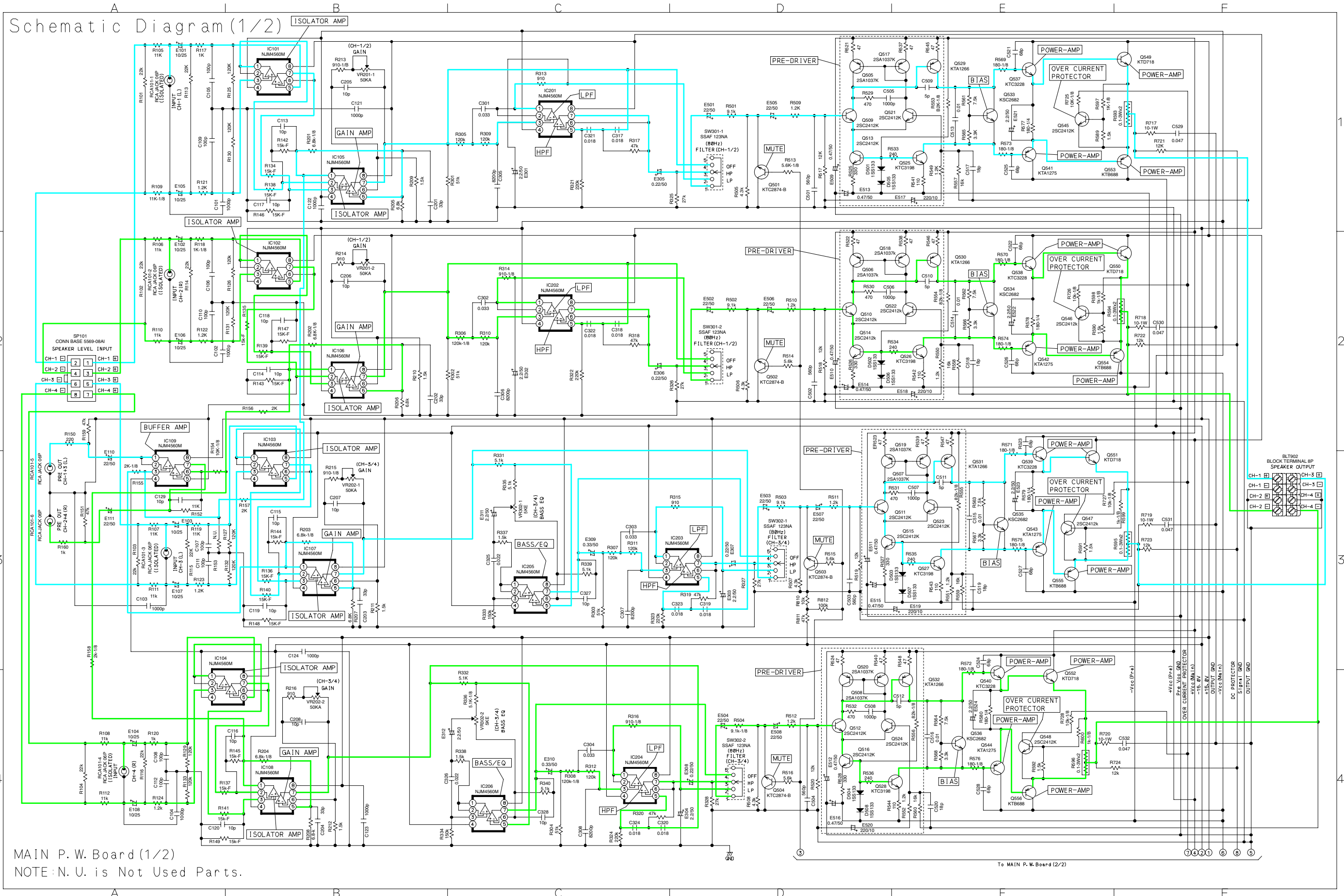

Schematic Diagram (2/2)

MAIN P. W. Board (2/2)

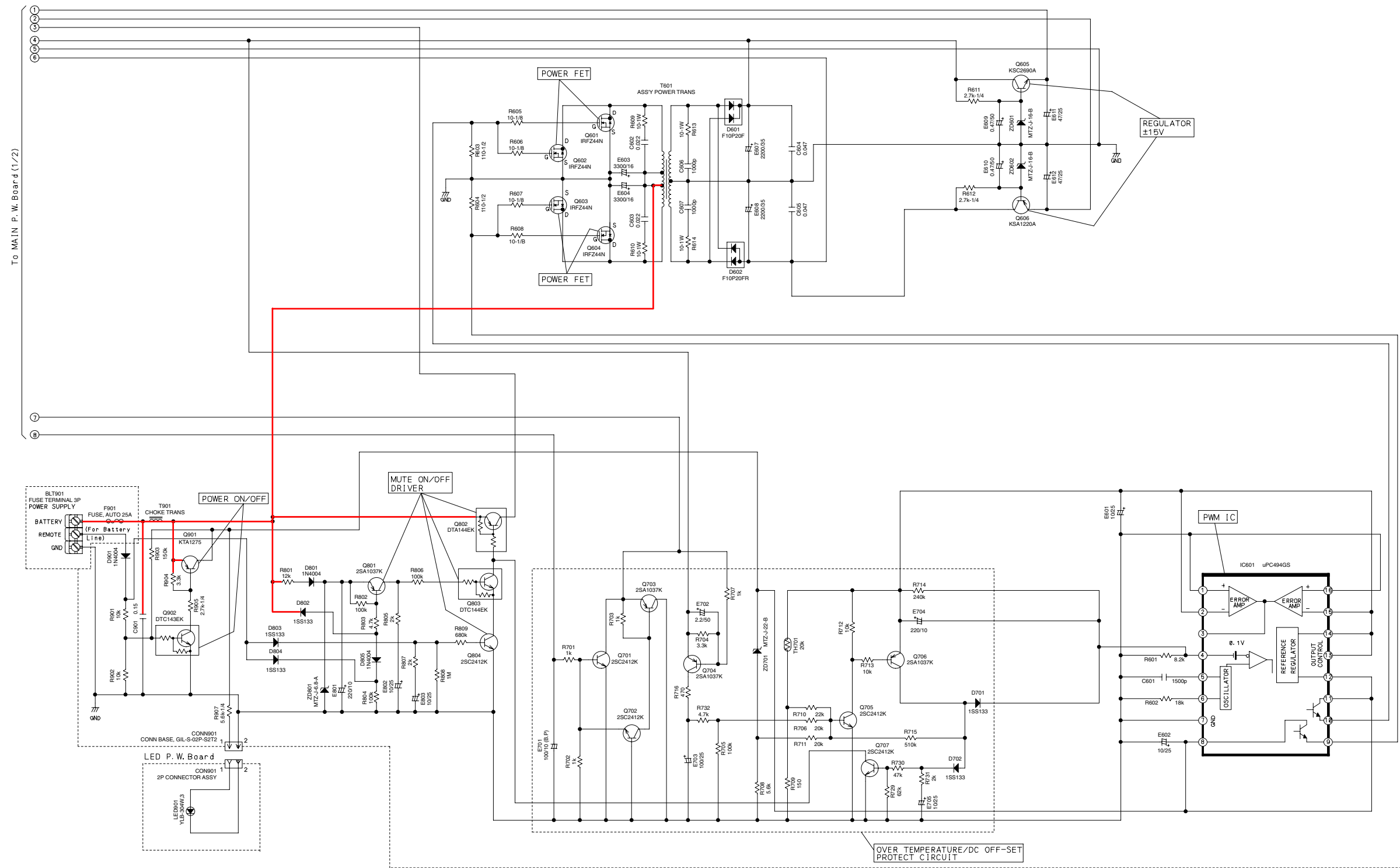

Terminal Voltage of IC/TR

IC101	
1	5.7m
2	5.7m
3	5.4m
4	-15.5
5	5.4m
6	6.0m
7	6.0m
8	15.3

IC102	
1	5.7m
2	5.7m
3	5.4m
4	-15.5
5	5.4m
6	6.0m
7	6.0m
8	15.3

IC103	
1	5.4m
2	5.4m
3	5.5m
4	-15.3
5	5.4m
6	5.6m
7	5.6m
8	15.2

IC104	
1	5.7m
2	5.7m
3	5.3m
4	-15.3
5	5.3m
6	6.0m
7	6.0m
8	15.2

IC105	
1	0.0
2	4.0m
3	3.3m
4	-15.5
5	0.0
6	0.0
7	10.8m
8	15.3

IC106	
1	0.0
2	3.3m
3	5.2m
4	-15.5
5	0.0
6	0.0
7	0.0
8	15.3

IC107	
1	0.0
2	3.5m
3	3.1m
4	-15.5
5	0.0
6	0.0
7	11.0m
8	15.3

IC108	
1	0.0
2	3.8m
3	3.2m
4	-15.5
5	0.0
6	0.0
7	4.0m
8	15.3

IC109	
1	0.0
2	0.0
3	0.0
4	-15.4
5	2.1m
6	2.1m
7	0.0
8	15.4

IC201	
1	22.6m
2	22.6m
3	22.4m
4	-15.5
5	10.4m
6	11.0m
7	11.0m
8	15.4

IC202	
1	11.3m
2	11.3m
3	11.3m
4	-15.5
5	10m
6	10.3m
7	10.3m
8	15.4

IC203	
1	13.1m
2	13.5m
3	14.3m
4	-15.5
5	9.2m
6	10.6m
7	10.6m
8	15.4

IC204	
1	13.5m
2	13.5m
3	13.2m
4	-15.5
5	10m
6	10.5m
7	10.5m
8	15.3

IC205	
1	6.8m
2	6.8m
3	6.8m
4	-15.5
5	11.4m
6	12.0m
7	12.0m
8	15.3

IC206	
1	7.2m
2	7.2m
3	6.9m
4	-15.5
5	4.5m
6	5.4m
7	5.4m
8	15.3

IC601			
1	0.0	9	5.15
2	4.97	10	5.65
3	83m	11	14.3
4	0.18	12	14.3
5	1.73	13	4.97
6	3.7	14	4.97
7	0.0	15	4.97
8	14.3	16	0.0

Ref. No.	E	C	B
Q501	0.0	0.0	-2.74
Q502	0.0	0.0	-2.75
Q503	0.0	0.0	-2.75
Q504	0.0	0.0	-2.75
Q505	25.4	24.6	24.8
Q506	25.4	24.6	24.8
Q507	25.4	24.6	24.8
Q508	25.4	24.6	24.8
Q509	-0.66	24.6	-47.6m
Q510	-0.65	24.6	-45.4m
Q511	-0.65	24.6	-46.8m
Q512	-0.65	24.6	-47.4m
Q513	-25.5	-0.64	-24.9
Q514	-25.5	-0.64	-24.9
Q515	-25.5	-0.64	-24.9
Q516	-25.5	-0.64	-24.9
Q517	25.4	24.8	24.8
Q518	25.4	24.8	24.8
Q519	25.4	24.8	24.8
Q520	25.4	24.8	24.8
Q521	-0.66	24.8	-44.0m
Q522	-0.65	24.8	-40.6m
Q523	-0.65	24.8	-43.5m
Q524	-0.65	24.8	-47.8m
Q525	-25.6	-1.09	-24.9
Q526	-25.6	-1.09	-24.9
Q527	-25.6	-1.09	-24.9
Q528	-25.6	-1.1	-24.9
Q529	25.2	1.09	24.6
Q530	25.2	1.1	24.6
Q531	25.2	1.1	24.6
Q532	25.2	1.1	24.6
Q533	-1.1	1.1	-0.45
Q534	-1.1	1.11	-0.45
Q535	-1.1	1.1	-0.45
Q536	-1.1	1.11	-0.46
Q537	0.55	25.4	1.11
Q538	0.56	25.4	1.12
Q539	0.55	25.4	1.11
Q540	0.56	25.4	1.12

Ref. No.	E	C	B
Q541	-0.5	-26.0	-1.1
Q542	-0.5	-26.0	-1.1
Q543	-0.5	-26.0	-1.1
Q544	-0.51	-26.0	-1.1
Q545	18.2m	25.4	19.5m
Q546	23.2m	25.4	23.5m
Q547	18.8m	25.4	18.5m
Q548	18.1m	25.4	18.4m
Q549	19.6m	25.4	0.54
Q550	23.5m	25.4	0.55
Q551	18.9m	25.4	0.55
Q552	18.5m	25.4	0.55
Q553	19.3m	-26.1	-0.5
Q554	22.8m	-26.1	-0.5
Q555	18.4m	-26.1	-0.5
Q556	17.5m	-26.1	-0.51
Q605	15.5	25.44	16.0
Q606	-15.6	-26.0	-16.2
Q701	0.0	25.4	4.13m
Q702	3.8m	25.4	0.0
Q703	25.4	0.0	25.4
Q704	25.4	25.0m	25.4
Q705	0.0	4.97	17.2m
Q706	4.97	-62.0m	4.97
Q707	25.4	14.9m	25.4
Q801	6.59	8.7m	6.59
Q802	14.4	-2.75	14.4
Q803	4.4m	14.4	8.5m
Q804	0.0	3.7m	0.56
Q901	14.4	14.4	13.7
Q902	0.0	23.2m	3.67

Ref. No.	G	D	S
Q601	5.64	14.4	2.33m
Q602	5.64	14.4	2.45m
Q603	5.65	14.4	1.67m
Q604	5.65	14.4	2.0m

[Measuring Conditions]

1. Power Supply Voltage : DC14.4V
2. Measuring Meter : Digital Multi Meter
3. Measuring Point Reference : Between GND
4. Measuring Conditions : No Signal Input

Exploded View (Cabinet)

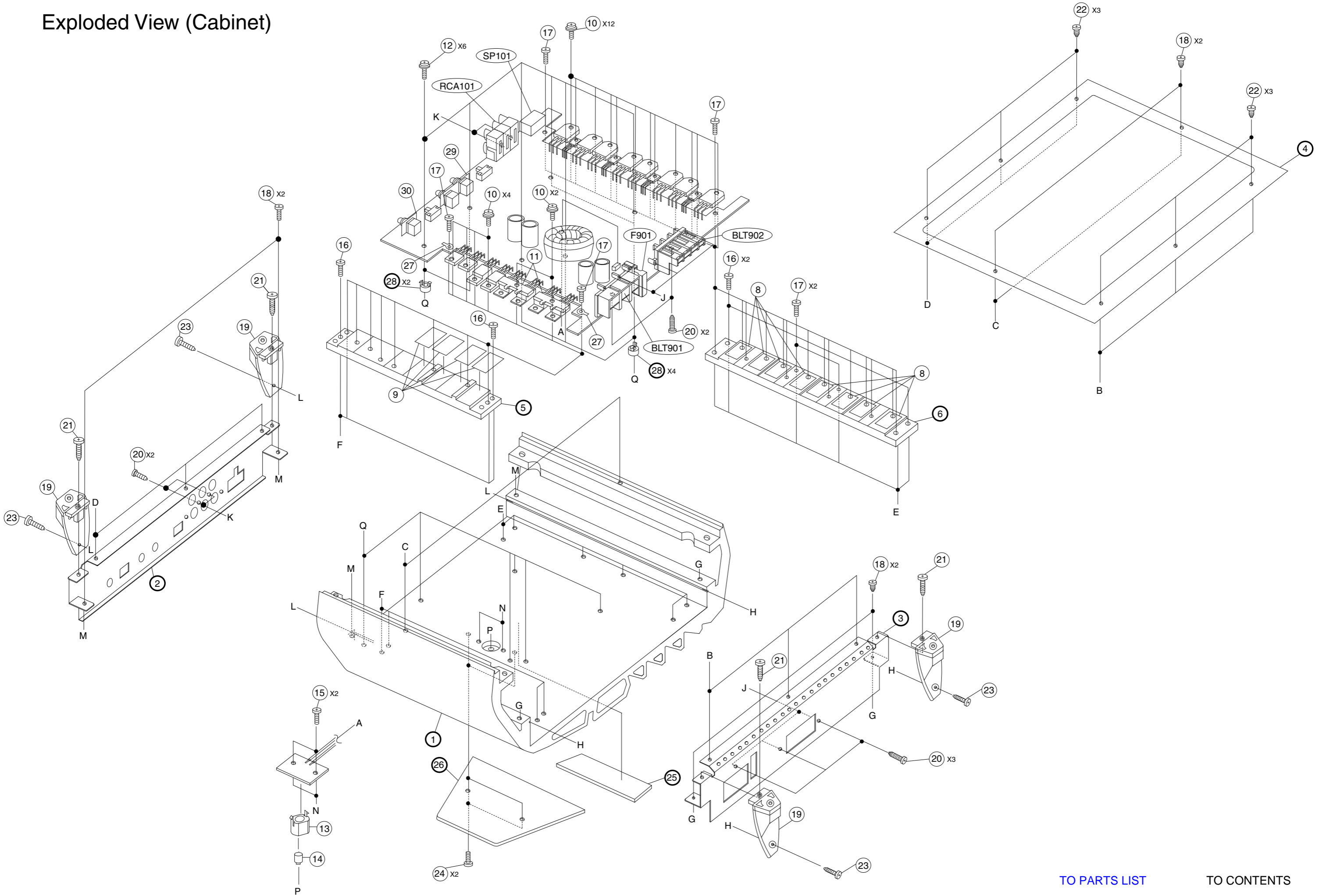

[TO PARTS LIST](#)

[TO CONTENTS](#)

MRP-F240

Cabinet Assembly Parts List		
Note : The part that has not PART NUMBER will not be supplied.		
1	-----	MAIN HEAT SINK
2	-----	CHAS,FRONT
3	-----	CHAS,REAR
4	-----	COVER BOTTOM
5	-----	SUB,HEAT SINK(RL)
6	-----	SUB HEAT SINK(D)
8	14E11487S01	INSULATOR,SHEET-B
9	14E20977S01	INSULATOR,SHEET-A
10	03E20922S01	SCR M3X11(S.W)TPG-TPT(YEL)
11	07E11146S01	BKT,TR
12	03E29347S01	SCR M3X11(W)TPG-TPT(YEL)
13	15E34943S01	HOLDER,LED
14	61E34941S01	LENS,LED
15	03E24424S01	SCR M2.6X5(B)TPG-TPT(YEL)
16	03E09417S10	SCR M3X10(B)TPG-TPT(YEL)
17	03E34940S01	SCR M3X14(SW)TPG-TPT(YEL)
18	03E20077S01	SCR M3X6(B)TPG-TPT(BLK)
19	29E34942S01	LEG,MTG
20	03E09416S10	SCR M3X8(P)TPG-TPT(BLK)
21	03E34938S01	SCR M3X11(B)MCH-TPT(BLK)
22	03E22133S01	SCR M2.6X6(B)MCH-TPT(BLK)
23	03E20919S01	SCR M3X8(B)TPG-TPT(BLK)
24	03E34939S01	WRENCH BOLT M2.6X11(WHT)
25	-----	BADGE,PLATE
26	-----	BADGE,V-POWER
27	29E23793S01	LUG,GND
28	-----	SUPPORT PWB
29	07E27744S01	BKT,GND-(A)
30	07E27745S01	BKT,GND-(B)

Electrical Parts List

*****MAIN P.W.Board		
=====IC's		
IC101	51E22130S01	IC, NJM 4560M-TE3
IC102	51E22130S01	IC, NJM 4560M-TE3
IC103	51E22130S01	IC, NJM 4560M-TE3
IC104	51E22130S01	IC, NJM 4560M-TE3
IC105	51E22130S01	IC, NJM 4560M-TE3
IC106	51E22130S01	IC, NJM 4560M-TE3
IC107	51E22130S01	IC, NJM 4560M-TE3
IC108	51E22130S01	IC, NJM 4560M-TE3
IC109	51E22130S01	IC, NJM 4560M-TE3
IC201	51E22130S01	IC, NJM 4560M-TE3
IC202	51E22130S01	IC, NJM 4560M-TE3
IC203	51E22130S01	IC, NJM 4560M-TE3
IC204	51E22130S01	IC, NJM 4560M-TE3
IC205	51E22130S01	IC, NJM 4560M-TE3
IC206	51E22130S01	IC, NJM 4560M-TE3
IC601	51E27890S01	IC,uPC 494GS
=====Transistors/FET's		
Q501	48E31104S01	TR,KTC2874-B-RD
Q502	48E31104S01	TR,KTC2874-B-RD
Q503	48E31104S01	TR,KTC2874-B-RD
Q504	48E31104S01	TR,KTC2874-B-RD
Q505	48E22900S01	TR,2SA1037K-CP
Q506	48E22900S01	TR,2SA1037K-CP
Q507	48E22900S01	TR,2SA1037K-CP
Q508	48E22900S01	TR,2SA1037K-CP
Q509	48E22902S01	TR,2SC2412K-T146-CP
Q510	48E22902S01	TR,2SC2412K-T146-CP
Q511	48E22902S01	TR,2SC2412K-T146-CP
Q512	48E22902S01	TR,2SC2412K-T146-CP
Q513	48E22902S01	TR,2SC2412K-T146-CP
Q514	48E22902S01	TR,2SC2412K-T146-CP
Q515	48E22902S01	TR,2SC2412K-T146-CP
Q516	48E22902S01	TR,2SC2412K-T146-CP
Q517	48E22900S01	TR,2SA1037K-CP
Q518	48E22900S01	TR,2SA1037K-CP
Q519	48E22900S01	TR,2SA1037K-CP
Q520	48E22900S01	TR,2SA1037K-CP
Q521	48E22902S01	TR,2SC2412K-T146-CP
Q522	48E22902S01	TR,2SC2412K-T146-CP
Q523	48E22902S01	TR,2SC2412K-T146-CP
Q524	48E22902S01	TR,2SC2412K-T146-CP
Q525	48E09088S01	TR,KTC 3198-Y-RD
Q526	48E09088S01	TR,KTC 3198-Y-RD
Q527	48E09088S01	TR,KTC 3198-Y-RD
Q528	48E09088S01	TR,KTC 3198-Y-RD
Q529	48E09036S02	TR,KTA 1266-Y-RD
Q530	48E09036S02	TR,KTA 1266-Y-RD
Q531	48E09036S02	TR,KTA 1266-Y-RD
Q532	48E09036S02	TR,KTA 1266-Y-RD
Q533	48E08329S01	TR,KSC 2682-Y
Q534	48E08329S01	TR,KSC 2682-Y
Q535	48E08329S01	TR,KSC 2682-Y
Q536	48E08329S01	TR,KSC 2682-Y

Q537	48E23701S01	TR KTC 3228-0-RD
Q538	48E23701S01	TR KTC 3228-0-RD
Q539	48E23701S01	TR KTC 3228-0-RD
Q540	48E23701S01	TR KTC 3228-0-RD
Q541	48E23700S01	TR KTA 1275-0-RD
Q542	48E23700S01	TR KTA 1275-0-RD
Q543	48E23700S01	TR KTA 1275-0-RD
Q544	48E23700S01	TR KTA 1275-0-RD
Q545	48E22902S01	TR,2SC2412K-T146-CP
Q546	48E22902S01	TR,2SC2412K-T146-CP
Q547	48E22902S01	TR,2SC2412K-T146-CP
Q548	48E22902S01	TR,2SC2412K-T146-CP
Q549	48E27748S01	TR,KTD 718-O
Q550	48E27748S01	TR,KTD 718-O
Q551	48E27748S01	TR,KTD 718-O
Q552	48E27748S01	TR,KTD 718-O
Q553	48E27747S01	TR,KTB 688-O
Q554	48E27747S01	TR,KTB 688-O
Q555	48E27747S01	TR,KTB 688-O
Q556	48E27747S01	TR,KTB 688-O
Q601	48E29536S01	FET,IRFZ 44N
Q602	48E29536S01	FET,IRFZ 44N
Q603	48E29536S01	FET,IRFZ 44N
Q604	48E29536S01	FET,IRFZ 44N
Q605	48E10027S01	TR,KSC 2690A-Y
Q606	48E05943S01	TR,KSA 1220A-Y
Q701	48E22902S01	TR,2SC2412K-T146-CP
Q702	48E22902S01	TR,2SC2412K-T146-CP
Q703	48E22900S01	TR,2SA1037K-CP
Q704	48E22900S01	TR,2SA1037K-CP
Q705	48E22902S01	TR,2SC2412K-T146-CP
Q706	48E22900S01	TR,2SA1037K-CP
Q707	48E22902S01	TR,2SC2412K-T146-CP
Q801	48E22900S01	TR,2SA1037K-CP
Q802	48E23697S01	TR,DTA 144EK-T146-CP
Q803	48E22555S01	TR,DTC 144EK-T146-CP
Q804	48E22902S01	TR,2SC2412K-T146-CP
Q901	48E23700S01	TR KTA 1275-0-RD
Q902	48E22903S01	TR,DTC 143EK-T-146-CP
=====Diodes		
D501	48E22916S01	DIO,1SS133-T-77-AX
D502	48E22916S01	DIO,1SS133-T-77-AX
D503	48E22916S01	DIO,1SS133-T-77-AX
D504	48E22916S01	DIO,1SS133-T-77-AX
D505	48E22916S01	DIO,1SS133-T-77-AX
D506	48E22916S01	DIO,1SS133-T-77-AX
D507	48E22916S01	DIO,1SS133-T-77-AX
D508	48E22916S01	DIO,1SS133-T-77-AX
D601	48T65059W01	DIO,REC F10P20F
D602	48T65059W02	DIO,REC F10P20FR
D701	48E22916S01	DIO,1SS133-T-77-AX
D702	48E22916S01	DIO,1SS133-T-77-AX
D801	48E33671S01	DIO,1N 4004-AX
D802	48E22916S01	DIO,1SS133-T-77-AX
D803	48E22916S01	DIO,1SS133-T-77-AX
D804	48E22916S01	DIO,1SS133-T-77-AX
D805	48E33671S01	DIO,1N 4004-AX

MRP-F240

D901	48E33671S01	DIO,1N 4004-AX
ZD601	48E22436S01	DIO,ZEN,MTZ-J-16-B-AX
ZD602	48E22436S01	DIO,ZEN,MTZ-J-16-B-AX
ZD701	48E08332S01	DIO,ZEN,MTZ-J-22-B-AX
ZD801	48E22917S01	DIO,ZEN,MTZ-J-6.8-A-AX
=====Switches		
SW301	40E20895S01	S/W SSAF 123NA((80Hz) FILTER)
SW302	40E20895S01	S/W SSAF 123NA((80Hz) FILTER)
=====Coil		
T901	24E29250S01	CHOKE TRANS 28MM 150
=====Thermistor		
TH701	48E20887S01	TH,YTD5-320(20K)-YEL
=====Transformer		
T601	25E29258S01	ASS'Y POWER TRANS
=====Capacitors		
C101	08E28769S01	CAP,CER 102-K-SL1H-CP
C102	08E28769S01	CAP,CER 102-K-SL1H-CP
C103	08E28769S01	CAP,CER 102-K-SL1H-CP
C104	08E28769S01	CAP,CER 102-K-SL1H-CP
C105	08E28764S01	CAP,CER 101-J-SL1H-CP
C106	08E28764S01	CAP,CER 101-J-SL1H-CP
C107	08E28764S01	CAP,CER 101-J-SL1H-CP
C108	08E28764S01	CAP,CER 101-J-SL1H-CP
C109	08E28764S01	CAP,CER 101-J-SL1H-CP
C110	08E28764S01	CAP,CER 101-J-SL1H-CP
C111	08E28764S01	CAP,CER 101-J-SL1H-CP
C112	08E28764S01	CAP,CER 101-J-SL1H-CP
C113	08E28760S01	CAP,CER 10R-D-SL1H-CP
C114	08E28760S01	CAP,CER 10R-D-SL1H-CP
C115	08E28760S01	CAP,CER 10R-D-SL1H-CP
C116	08E28760S01	CAP,CER 10R-D-SL1H-CP
C117	08E28760S01	CAP,CER 10R-D-SL1H-CP
C118	08E28760S01	CAP,CER 10R-D-SL1H-CP
C119	08E28760S01	CAP,CER 10R-D-SL1H-CP
C120	08E28760S01	CAP,CER 10R-D-SL1H-CP
C121	08E28769S01	CAP,CER 102-K-SL1H-CP
C122	08E28769S01	CAP,CER 102-K-SL1H-CP
C123	08E28769S01	CAP,CER 102-K-SL1H-CP
C124	08E28769S01	CAP,CER 102-K-SL1H-CP
C129	08E28760S01	CAP,CER 10R-D-SL1H-CP
C201	08E28762S01	CAP,CER 33R-J-SL1H-CP
C202	08E28762S01	CAP,CER 33R-J-SL1H-CP
C203	08E28762S01	CAP,CER 33R-J-SL1H-CP
C204	08E28762S01	CAP,CER 33R-J-SL1H-CP
C205	08E28760S01	CAP,CER 10R-D-SL1H-CP
C206	08E28760S01	CAP,CER 10R-D-SL1H-CP
C207	08E28760S01	CAP,CER 10R-D-SL1H-CP
C208	08E28760S01	CAP,CER 10R-D-SL1H-CP
C301	08E33406S01	CAP,MYL,333-J-RD
C302	08E33406S01	CAP,MYL,333-J-RD
C303	08E33406S01	CAP,MYL,333-J-RD
C304	08E33406S01	CAP,MYL,333-J-RD
C305	08E34952S01	CAP,MYL,822-J-RD
C306	08E34952S01	CAP,MYL,822-J-RD
C307	08E34952S01	CAP,MYL,822-J-RD

C308	08E34952S01	CAP,MYL,822-J-RD
C317	08E34953S01	CAP,MYL,183-J-RD
C318	08E34953S01	CAP,MYL,183-J-RD
C319	08E34953S01	CAP,MYL,183-J-RD
C320	08E34953S01	CAP,MYL,183-J-RD
C321	08E34953S01	CAP,MYL,183-J-RD
C322	08E34953S01	CAP,MYL,183-J-RD
C323	08E34953S01	CAP,MYL,183-J-RD
C324	08E34953S01	CAP,MYL,183-J-RD
C325	08E33353S01	CAP,MYL,223-J-RD
C326	08E33353S01	CAP,MYL,223-J-RD
C327	08E28760S01	CAP,CER 10R-D-SL1H-CP
C328	08E28760S01	CAP,CER 10R-D-SL1H-CP
C501	08E31814S01	CAP,CER 561-K-SL1H-CP
C502	08E31814S01	CAP,CER 561-K-SL1H-CP
C503	08E31814S01	CAP,CER 561-K-SL1H-CP
C504	08E31814S01	CAP,CER 561-K-SL1H-CP
C505	08E28769S01	CAP,CER 102-K-SL1H-CP
C506	08E28769S01	CAP,CER 102-K-SL1H-CP
C507	08E28769S01	CAP,CER 102-K-SL1H-CP
C508	08E28769S01	CAP,CER 102-K-SL1H-CP
C509	06E32049S01	CAP,CER 5R0-C-SL1H-CP
C510	06E32049S01	CAP,CER 5R0-C-SL1H-CP
C511	06E32049S01	CAP,CER 5R0-C-SL1H-CP
C512	06E32049S01	CAP,CER 5R0-C-SL1H-CP
C513	08E33405S01	CAP,MYL,103-J-RD
C514	08E33405S01	CAP,MYL,103-J-RD
C515	08E33405S01	CAP,MYL,103-J-RD
C516	08E33405S01	CAP,MYL,103-J-RD
C517	08E29171S01	CAP,CER 18R-J-SL1H-CP
C518	08E29171S01	CAP,CER 18R-J-SL1H-CP
C519	08E29171S01	CAP,CER 18R-J-SL1H-CP
C520	08E29171S01	CAP,CER 18R-J-SL1H-CP
C521	08E31812S01	CAP,CER 68R-J-SL1H-CP
C522	08E31812S01	CAP,CER 68R-J-SL1H-CP
C523	08E31812S01	CAP,CER 68R-J-SL1H-CP
C524	08E31812S01	CAP,CER 68R-J-SL1H-CP
C525	08E31812S01	CAP,CER 68R-J-SL1H-CP
C526	08E31812S01	CAP,CER 68R-J-SL1H-CP
C527	08E31812S01	CAP,CER 68R-J-SL1H-CP
C528	08E31812S01	CAP,CER 68R-J-SL1H-CP
C529	08E33668S01	CAP,MYL,473-J-RD
C530	08E33668S01	CAP,MYL,473-J-RD
C531	08E33668S01	CAP,MYL,473-J-RD
C532	08E33668S01	CAP,MYL,473-J-RD
C601	08E25318S01	CAP,TF,AMCS 152-J-RD
C602	08E33353S01	CAP,MYL,223-J-RD
C603	08E33353S01	CAP,MYL,223-J-RD
C604	08E33668S01	CAP,MYL,473-J-RD
C605	08E33668S01	CAP,MYL,473-J-RD
C606	08E34960S01	CAP,MYL,102-J-RD
C607	08E34960S01	CAP,MYL,102-J-RD
C901	08E31021S01	CAP, MF 154-J-63V-RD
E101	23E34950S01	CAP ELEC SHL 10/25-M-RD
E102	23E34950S01	CAP ELEC SHL 10/25-M-RD
E103	23E34950S01	CAP ELEC SHL 10/25-M-RD
E104	23E34950S01	CAP ELEC SHL 10/25-M-RD

E105	23E34950S01	CAP ELEC SHL 10/25-M-RD
E106	23E34950S01	CAP ELEC SHL 10/25-M-RD
E107	23E34950S01	CAP ELEC SHL 10/25-M-RD
E108	23E34950S01	CAP ELEC SHL 10/25-M-RD
E110	23E33351S01	CAP,ELEC,SHL 22/50-M-RD
E111	23E33351S01	CAP,ELEC,SHL 22/50-M-RD
E301	23E33398S01	CAP,ELEC,SHL 2.2/50-M-RD
E302	23E33398S01	CAP,ELEC,SHL 2.2/50-M-RD
E303	23E33398S01	CAP,ELEC,SHL 2.2/50-M-RD
E304	23E33398S01	CAP,ELEC,SHL 2.2/50-M-RD
E305	23E34948S01	CAP ELEC SHL 0.22/50-M-RD
E306	23E34948S01	CAP ELEC SHL 0.22/50-M-RD
E307	23E34948S01	CAP ELEC SHL 0.22/50-M-RD
E308	23E34948S01	CAP ELEC SHL 0.22/50-M-RD
E309	23E34949S01	CAP,ELEC,SHL 0.33/50-M-RD
E310	23E34949S01	CAP,ELEC,SHL 0.33/50-M-RD
E311	23E33398S01	CAP,ELEC,SHL 2.2/50-M-RD
E312	23E33398S01	CAP,ELEC,SHL 2.2/50-M-RD
E501	23E33351S01	CAP,ELEC,SHL 22/50-M-RD
E502	23E33351S01	CAP,ELEC,SHL 22/50-M-RD
E503	23E33351S01	CAP,ELEC,SHL 22/50-M-RD
E504	23E33351S01	CAP,ELEC,SHL 22/50-M-RD
E505	23E33351S01	CAP,ELEC,SHL 22/50-M-RD
E506	23E33351S01	CAP,ELEC,SHL 22/50-M-RD
E507	23E33351S01	CAP,ELEC,SHL 22/50-M-RD
E508	23E33351S01	CAP,ELEC,SHL 22/50-M-RD
E509	23E33664S01	CAP,ELEC,SHL 0.47/50-M-RD
E510	23E33664S01	CAP,ELEC,SHL 0.47/50-M-RD
E511	23E33664S01	CAP,ELEC,SHL 0.47/50-M-RD
E512	23E33664S01	CAP,ELEC,SHL 0.47/50-M-RD
E513	23E33664S01	CAP,ELEC,SHL 0.47/50-M-RD
E514	23E33664S01	CAP,ELEC,SHL 0.47/50-M-RD
E515	23E33664S01	CAP,ELEC,SHL 0.47/50-M-RD
E516	23E33664S01	CAP,ELEC,SHL 0.47/50-M-RD
E517	23E33663S01	CAP,ELEC,SHL 220/10-M-RD
E518	23E33663S01	CAP,ELEC,SHL 220/10-M-RD
E519	23E33663S01	CAP,ELEC,SHL 220/10-M-RD
E520	23E33663S01	CAP,ELEC,SHL 220/10-M-RD
E521	23E33398S01	CAP,ELEC,SHL 2.2/50-M-RD
E522	23E33398S01	CAP,ELEC,SHL 2.2/50-M-RD
E523	23E33398S01	CAP,ELEC,SHL 2.2/50-M-RD
E524	23E33398S01	CAP,ELEC,SHL 2.2/50-M-RD
E601	23E34950S01	CAP ELEC SHL 10/25-M-RD
E602	23E34950S01	CAP ELEC SHL 10/25-M-RD
E603	23E29269S01	CAP,ELEC,3300/16-M
E604	23E29269S01	CAP,ELEC,3300/16-M
E607	23E09551S02	CAP,ELEC KMG 2200/35
E608	23E09551S02	CAP,ELEC KMG 2200/35
E609	23E33664S01	CAP,ELEC,SHL 0.47/50-M-

		RD
E610	23E33664S01	CAP,ELEC,SHL 0.47/50-M-RD
E611	23E33348S01	CAP,ELEC,SHL 47/25-M-RD
E612	23E33348S01	CAP,ELEC,SHL 47/25-M-RD
E701	23E11142S01	CAP,ELEC,100/10-M-BP-RD
E702	23E33398S01	CAP,ELEC,SHL 2.2/50-M-RD
E703	23E33397S01	CAP,ELEC,SHL 100/25-M-RD
E704	23E33663S01	CAP,ELEC,SHL 220/10-M-RD
E705	23E34950S01	CAP ELEC SHL 10/25-M-RD
E801	23E33663S01	CAP,ELEC,SHL 220/10-M-RD
E802	23E34950S01	CAP ELEC SHL 10/25-M-RD
E803	23E34950S01	CAP ELEC SHL 10/25-M-RD
=====Resistors		
CJ001	06E22039S01	RES,CF,0R0-J-1/8-CP
CJ002	06E22039S01	RES,CF,0R0-J-1/8-CP
CJ003	06E22039S01	RES,CF,0R0-J-1/8-CP
CJ005	06E22039S01	RES,CF,0R0-J-1/8-CP
R101	06E28535S01	RES,CF,223-J-1/16-CP
R102	06E28535S01	RES,CF,223-J-1/16-CP
R103	06E28535S01	RES,CF,223-J-1/16-CP
R104	06E28535S01	RES,CF,223-J-1/16-CP
R105	06E32035S01	RES,CF,113-J-1/16-CP
R106	06E32035S01	RES,CF,113-J-1/16-CP
R107	06E32035S01	RES,CF,113-J-1/16-CP
R108	06E32035S01	RES,CF,113-J-1/16-CP
R109	06E23685S01	RES,CF,113-J-1/8-CP
R110	06E32035S01	RES,CF,113-J-1/16-CP
R111	06E32035S01	RES,CF,113-J-1/16-CP
R112	06E32035S01	RES,CF,113-J-1/16-CP
R113	06E28535S01	RES,CF,223-J-1/16-CP
R114	06E28535S01	RES,CF,223-J-1/16-CP
R115	06E28535S01	RES,CF,223-J-1/16-CP
R116	06E28535S01	RES,CF,223-J-1/16-CP
R117	06E28533S01	RES,CF,102-J-1/16-CP
R118	06E22030S01	RES,CF,102-J-1/8-CP
R119	06E28533S01	RES,CF,102-J-1/16-CP
R120	06E28533S01	RES,CF,102-J-1/16-CP
R121	06E28788S01	RES,CF,122-J-1/16-CP
R122	06E28788S01	RES,CF,122-J-1/16-CP
R123	06E28788S01	RES,CF,122-J-1/16-CP
R124	06E28788S01	RES,CF,122-J-1/16-CP
R125	06E32037S01	RES,CF,124-J-1/16-CP
R126	06E32037S01	RES,CF,124-J-1/16-CP
R127	06E32037S01	RES,CF,124-J-1/16-CP
R129	06E32037S01	RES,CF,124-J-1/16-CP
R130	06E32037S01	RES,CF,124-J-1/16-CP
R131	06E32037S01	RES,CF,124-J-1/16-CP
R132	06E32037S01	RES,CF,124-J-1/16-CP
R133	06E32037S01	RES,CF,124-J-1/16-CP
R134	06E33657S01	RES,CF,153-F-1/16-CP
R135	06E33657S01	RES,CF,153-F-1/16-CP
R136	06E33657S01	RES,CF,153-F-1/16-CP
R137	06E33657S01	RES,CF,153-F-1/16-CP
R138	06E33657S01	RES,CF,153-F-1/16-CP
R139	06E33657S01	RES,CF,153-F-1/16-CP
R140	06E33657S01	RES,CF,153-F-1/16-CP

MRP-F240

R141	06E33657S01	RES,CF,153-F-1/16-CP
R142	06E33657S01	RES,CF,153-F-1/16-CP
R143	06E33657S01	RES,CF,153-F-1/16-CP
R144	06E33657S01	RES,CF,153-F-1/16-CP
R145	06E33657S01	RES,CF,153-F-1/16-CP
R146	06E33657S01	RES,CF,153-F-1/16-CP
R147	06E33657S01	RES,CF,153-F-1/16-CP
R148	06E33657S01	RES,CF,153-F-1/16-CP
R149	06E33657S01	RES,CF,153-F-1/16-CP
R150	06E31149S01	RES,CF,221-J-1/16-CP
R151	06E31160S01	RES,CF,473-J-1/16-CP
R152	06E32035S01	RES,CF,113-J-1/16-CP
R154	06E26014S01	RES,CF,103-J-1/8-CP
R155	06E23737S01	RES,CF,202-J-1/8-CP
R156	06E32034S01	RES,CF,202-J-1/16-CP
R157	06E32034S01	RES,CF,202-J-1/16-CP
R158	06E23737S01	RES,CF,202-J-1/8-CP
R159	06E31160S01	RES,CF,473-J-1/16-CP
R160	06E28533S01	RES,CF,102-J-1/16-CP
R201	06E22656S01	RES,CF,682-J-1/8-CP
R202	06E22656S01	RES,CF,682-J-1/8-CP
R203	06E22656S01	RES,CF,682-J-1/8-CP
R204	06E22656S01	RES,CF,682-J-1/8-CP
R205	06E28622S01	RES,CF,682-J-1/16-CP
R206	06E28622S01	RES,CF,682-J-1/16-CP
R207	06E28622S01	RES,CF,682-J-1/16-CP
R208	06E28622S01	RES,CF,682-J-1/16-CP
R209	06E31152S01	RES,CF,152-J-1/16-CP
R210	06E31152S01	RES,CF,152-J-1/16-CP
R211	06E31152S01	RES,CF,152-J-1/16-CP
R212	06E31152S01	RES,CF,152-J-1/16-CP
R213	06E23735S01	RES,CF,911-J-1/8-CP
R214	06E32033S01	RES,CF,911-J-1/16-CP
R215	06E23735S01	RES,CF,911-J-1/8-CP
R216	06E32033S01	RES,CF,911-J-1/16-CP
R301	06E31803S01	RES,CF,513-J-1/16-CP
R302	06E31803S01	RES,CF,513-J-1/16-CP
R303	06E31803S01	RES,CF,513-J-1/16-CP
R304	06E31803S01	RES,CF,513-J-1/16-CP
R305	06E32037S01	RES,CF,124-J-1/16-CP
R306	06E22922S01	RES,CF,124-J-1/8-CP
R307	06E32037S01	RES,CF,124-J-1/16-CP
R308	06E22922S01	RES,CF,124-J-1/8-CP
R309	06E32037S01	RES,CF,124-J-1/16-CP
R310	06E32037S01	RES,CF,124-J-1/16-CP
R311	06E32037S01	RES,CF,124-J-1/16-CP
R312	06E32037S01	RES,CF,124-J-1/16-CP
R313	06E32033S01	RES,CF,911-J-1/16-CP
R314	06E23735S01	RES,CF,911-J-1/8-CP
R315	06E32033S01	RES,CF,911-J-1/16-CP
R316	06E23735S01	RES,CF,911-J-1/8-CP
R317	06E31160S01	RES,CF,473-J-1/16-CP
R318	06E31160S01	RES,CF,473-J-1/16-CP
R319	06E31160S01	RES,CF,473-J-1/16-CP
R320	06E31160S01	RES,CF,473-J-1/16-CP
R321	06E31163S01	RES,CF,224-J-1/16-CP
R322	06E31163S01	RES,CF,224-J-1/16-CP

R323	06E31163S01	RES,CF,224-J-1/16-CP
R324	06E31163S01	RES,CF,224-J-1/16-CP
R325	06E28794S01	RES,CF,273-J-1/16-CP
R326	06E28794S01	RES,CF,273-J-1/16-CP
R327	06E28794S01	RES,CF,273-J-1/16-CP
R328	06E28794S01	RES,CF,273-J-1/16-CP
R331	06E31156S01	RES,CF,512-J-1/16-CP
R332	06E31156S01	RES,CF,512-J-1/16-CP
R333	06E31683S01	RES,CF,154-J-1/16-CP
R334	06E31683S01	RES,CF,154-J-1/16-CP
R335	06E31156S01	RES,CF,512-J-1/16-CP
R336	06E29209S01	RES,CF,512-J-1/8-CP
R337	06E31152S01	RES,CF,152-J-1/16-CP
R338	06E31152S01	RES,CF,152-J-1/16-CP
R339	06E31156S01	RES,CF,512-J-1/16-CP
R340	06E31156S01	RES,CF,512-J-1/16-CP
R501	06E28791S01	RES,CF,912-J-1/16-CP
R502	06E28791S01	RES,CF,912-J-1/16-CP
R503	06E28791S01	RES,CF,912-J-1/16-CP
R504	06E27832S01	RES,CF,912-J-1/8-CP
R505	06E33277S01	RES,CF,432-J-1/16-CP
R506	06E33277S01	RES,CF,432-J-1/16-CP
R507	06E33277S01	RES,CF,432-J-1/16-CP
R508	06E33277S01	RES,CF,432-J-1/16-CP
R509	06E28788S01	RES,CF,122-J-1/16-CP
R510	06E28788S01	RES,CF,122-J-1/16-CP
R511	06E28788S01	RES,CF,122-J-1/16-CP
R512	06E28788S01	RES,CF,122-J-1/16-CP
R513	06E21162S01	RES,CF,562-J-1/8-CP
R514	06E28790S01	RES,CF,562-J-1/16-CP
R515	06E28790S01	RES,CF,562-J-1/16-CP
R516	06E28790S01	RES,CF,562-J-1/16-CP
R517	06E28792S01	RES,CF,123-J-1/16-CP
R518	06E28792S01	RES,CF,123-J-1/16-CP
R519	06E28792S01	RES,CF,123-J-1/16-CP
R520	06E28792S01	RES,CF,123-J-1/16-CP
R521	06E31172S01	RES,CF,47R-J-1/16-CP
R522	06E31172S01	RES,CF,47R-J-1/16-CP
R523	06E31172S01	RES,CF,47R-J-1/16-CP
R524	06E31172S01	RES,CF,47R-J-1/16-CP
R525	06E28786S01	RES,CF,331-J-1/16-CP
R526	06E28786S01	RES,CF,331-J-1/16-CP
R527	06E28786S01	RES,CF,331-J-1/16-CP
R528	06E28786S01	RES,CF,331-J-1/16-CP
R529	06E28548S01	RES,CF,471-J-1/16-CP
R530	06E28548S01	RES,CF,471-J-1/16-CP
R531	06E28548S01	RES,CF,471-J-1/16-CP
R532	06E28548S01	RES,CF,471-J-1/16-CP
R533	06E34946S01	RES,CF,241-J-1/16-CP
R534	06E34946S01	RES,CF,241-J-1/16-CP
R535	06E34946S01	RES,CF,241-J-1/16-CP
R536	06E34946S01	RES,CF,241-J-1/16-CP
R537	06E31172S01	RES,CF,47R-J-1/16-CP
R538	06E31172S01	RES,CF,47R-J-1/16-CP
R539	06E31172S01	RES,CF,47R-J-1/16-CP
R540	06E31172S01	RES,CF,47R-J-1/16-CP
R541	06E32032S01	RES,CF,111-J-1/16-CP

MRP-F240

R542	06E32032S01	RES,CF,111-J-1/16-CP
R543	06E32032S01	RES,CF,111-J-1/16-CP
R544	06E32032S01	RES,CF,111-J-1/16-CP
R545	06E31172S01	RES,CF,47R-J-1/16-CP
R546	06E31172S01	RES,CF,47R-J-1/16-CP
R547	06E31172S01	RES,CF,47R-J-1/16-CP
R548	06E31172S01	RES,CF,47R-J-1/16-CP
R549	06E28788S01	RES,CF,122-J-1/16-CP
R550	06E28788S01	RES,CF,122-J-1/16-CP
R551	06E28788S01	RES,CF,122-J-1/16-CP
R552	06E28788S01	RES,CF,122-J-1/16-CP
R553	06E28950S01	RES,CF,823-J-1/8-CP
R554	06E28950S01	RES,CF,823-J-1/8-CP
R555	06E28950S01	RES,CF,823-J-1/8-CP
R556	06E28950S01	RES,CF,823-J-1/8-CP
R557	06E34947S01	RES,CF,163-J-1/16-CP
R558	06E34947S01	RES,CF,163-J-1/16-CP
R559	06E34947S01	RES,CF,163-J-1/16-CP
R560	06E34947S01	RES,CF,163-J-1/16-CP
R561	06E33234S01	RES,CF,752-J-1/16-CP
R562	06E33234S01	RES,CF,752-J-1/16-CP
R563	06E33234S01	RES,CF,752-J-1/16-CP
R564	06E33234S01	RES,CF,752-J-1/16-CP
R565	06E31174S01	RES,CF,332-J-1/16-CP
R566	06E31174S01	RES,CF,332-J-1/16-CP
R567	06E31174S01	RES,CF,332-J-1/16-CP
R568	06E31174S01	RES,CF,332-J-1/16-CP
R569	06E34945S01	RES,CF,181-J-1/8-CP
R570	06E34945S01	RES,CF,181-J-1/8-CP
R571	06E34945S01	RES,CF,181-J-1/8-CP
R572	06E34945S01	RES,CF,181-J-1/8-CP
R573	06E34945S01	RES,CF,181-J-1/8-CP
R574	06E34945S01	RES,CF,181-J-1/8-CP
R575	06E34945S01	RES,CF,181-J-1/8-CP
R576	06E34945S01	RES,CF,181-J-1/8-CP
R577	06E24395S01	RES,CF,181R-J-1/4-CP
R578	06E24395S01	RES,CF,181R-J-1/4-CP
R579	06E24395S01	RES,CF,181R-J-1/4-CP
R580	06E24395S01	RES,CF,181R-J-1/4-CP
R589	06E31152S01	RES,CF,152-J-1/16-CP
R590	06E31152S01	RES,CF,152-J-1/16-CP
R591	06E31152S01	RES,CF,152-J-1/16-CP
R592	06E31152S01	RES,CF,152-J-1/16-CP
R593	06E32024S01	RES, MPR 0.1J-3WX2
R594	06E32024S01	RES, MPR 0.1J-3WX2
R595	06E32024S01	RES, MPR 0.1J-3WX2
R596	06E32024S01	RES, MPR 0.1J-3WX2
R597	06E22030S01	RES,CF,102-J-1/8-CP
R598	06E22030S01	RES,CF,102-J-1/8-CP
R599	06E22030S01	RES,CF,102-J-1/8-CP
R600	06E22030S01	RES,CF,102-J-1/8-CP
R601	06E31175S01	RES,CF,822-J-1/16-CP
R602	06E28793S01	RES,CF,183-J-1/16-CP
R603	06E32062S01	RES,MO,111-J-1/2W-AX
R604	06E32062S01	RES,MO,111-J-1/2W-AX
R605	01E25506S01	RES,CF,10R-J-1/8-CP
R606	01E25506S01	RES,CF,10R-J-1/8-CP

R607	01E25506S01	RES,CF,10R-J-1/8-CP
R608	01E25506S01	RES,CF,10R-J-1/8-CP
R609	06E20907S01	RES MO 1W ERG 1SJ 100E-RD
R610	06E20907S01	RES MO 1W ERG 1SJ 100E-RD
R611	06E23694S01	RES,CF,272-J-1/4-CP
R612	06E23694S01	RES,CF,272-J-1/4-CP
R613	06E20907S01	RES MO 1W ERG 1SJ 100E-RD
R614	06E20907S01	RES MO 1W ERG 1SJ 100E-RD
R701	06E28533S01	RES,CF,102-J-1/16-CP
R702	06E28533S01	RES,CF,102-J-1/16-CP
R703	06E28533S01	RES,CF,102-J-1/16-CP
R704	06E31174S01	RES,CF,332-J-1/16-CP
R705	06E28537S01	RES,CF,104-J-1/16-CP
R706	06E31157S01	RES,CF,203-J-1/16-CP
R707	06E28533S01	RES,CF,102-J-1/16-CP
R708	06E28790S01	RES,CF,562-J-1/16-CP
R709	06E31800S01	RES,CF,151-J-1/16-CP
R710	06E28535S01	RES,CF,223-J-1/16-CP
R711	06E31157S01	RES,CF,203-J-1/16-CP
R712	06E28534S01	RES,CF,103-J-1/16-CP
R713	06E28534S01	RES,CF,103-J-1/16-CP
R714	06E31806S01	RES,CF,244-J-1/16-CP
R715	06E32048S01	RES,CF,514-J-1/16-CP
R716	06E28548S01	RES,CF,471-J-1/16-CP
R717	06E20907S01	RES MO 1W ERG 1SJ 100E-RD
R718	06E20907S01	RES MO 1W ERG 1SJ 100E-RD
R719	06E20907S01	RES MO 1W ERG 1SJ 100E-RD
R720	06E20907S01	RES MO 1W ERG 1SJ 100E-RD
R721	06E28792S01	RES,CF,123-J-1/16-CP
R722	06E28792S01	RES,CF,123-J-1/16-CP
R723	06E28792S01	RES,CF,123-J-1/16-CP
R724	06E28792S01	RES,CF,123-J-1/16-CP
R725	06E26014S01	RES,CF,103-J-1/8-CP
R726	06E26014S01	RES,CF,103-J-1/8-CP
R727	06E26014S01	RES,CF,103-J-1/8-CP
R728	06E26014S01	RES,CF,103-J-1/8-CP
R729	06E28796S01	RES,CF,623-J-1/16-CP
R730	06E31160S01	RES,CF,473-J-1/16-CP
R731	06E32034S01	RES,CF,202-J-1/16-CP
R732	06E28549S01	RES,CF,472-J-1/16-CP
R801	06E28792S01	RES,CF,123-J-1/16-CP
R802	06E28537S01	RES,CF,104-J-1/16-CP
R803	06E28549S01	RES,CF,472-J-1/16-CP
R804	06E28537S01	RES,CF,104-J-1/16-CP
R805	06E32034S01	RES,CF,202-J-1/16-CP
R806	06E28537S01	RES,CF,104-J-1/16-CP
R807	06E32034S01	RES,CF,202-J-1/16-CP
R808	06E31685S01	RES,CF,105-J-1/16-CP
R809	06E31684S01	RES,CF,684-J-1/16-CP

MRP-F240

R810	06E28534S01	RES,CF,103-J-1/16-CP
R811	06E31160S01	RES,CF,473-J-1/16-CP
R812	06E28537S01	RES,CF,104-J-1/16-CP
R901	06E28534S01	RES,CF,103-J-1/16-CP
R902	06E28534S01	RES,CF,103-J-1/16-CP
R903	06E31683S01	RES,CF,154-J-1/16-CP
R904	06E31174S01	RES,CF,332-J-1/16-CP
R905	06E23694S01	RES,CF, 272-J-1/4-CP
R907	06E30008S01	RES,CF, 562-J-1/4-CP
VR201	18E20880S01	VR,50KAX2 RK0971210(GAIN)
VR202	18E20880S01	VR,50KAX2 RK0971210(GAIN)
VR302	18E27746S01	VR 5KEX2(RK0971210) (BASS EQ)
*****LED P.W.Board		
=====LED		
LED901	48E34944S01	LED-LAMP BLUE,YLB- 304W,3
=====Connector		
CON901	01E28616S01	2P CONNECTOR ASS'Y
*****Miscellaneous		
BLT901	09E32028S01	FUSE TERMINAL 3P (POWER SUPPLY)
BLT902	09E29255S01	BLOCK TERMINAL 8P (SPEAKER OUTPUT)
F901	65E27881S01	FUSE,AUTO 25A(257025) (For Battery Line)
RCA101	09E32066S01	RCA JACK 06P(ISOLATED) (INPUT/PRE OUT)
SP101	09E23725S01	CONN BASE 5569- 08AI(BLACK) (SPEAKER LEVEL INPUT)